

Apr 1, 2024

GURU Network: Multi Chain AI Compute Layer

Lite Paper

Abstract

As blockchain and AI technologies mature, orchestrating their interactions with real-world business processes becomes increasingly crucial. Traditional smart contracts, while effective within their native environments, are often limited by a lack of secure, reliable real-world interaction. On the other hand, existing AI models perform well with simple tasks but face significant challenges when integrated into automated multi-step processes and participant flows.

The Guru Network design addresses this gap by focusing on AI-driven user flow orchestration across both on-chain and off-chain sides, providing a robust framework for real-world user actions and blockchain business process automation (BBPA). With Cross-Chain Interoperability Protocol (CCIP) protocol integration Guru Network can effectively serve as Multi Chain AI compute Layer 3 which allows apps and users to natively embed orchestrated AI Agents into their routines and earn Network participant rewards.

Contents

[Abstract](#)

[Contents](#)

[Guru Enlightenment Introduction](#)

[Network Participants Ecosystem](#)

[Web3 Infrastructure](#)

[Flow Orchestrator](#)

[BBPA Engine Event Bus as Network Native Oracle](#)

[AI Compute Oracles as Prophets](#)

[Real-World Impact and Network Growth](#)

[User Engagement and Participation](#)

[Web2 and Off Chain Infrastructure](#)

[BBPA Engine REST API](#)

[BBPA Engine Tasklist](#)

[AI Compute Individual Agents Ecosystem](#)

[Data aware Individual Agents Ecosystem](#)

[Ecosystem Atomic Franchise Mechanism](#)

[Ecosystem Rewards and Incentives](#)

[Multi Chain Interoperability Layer \(CCIP\)](#)

[Roadmap](#)

[\\$GURU Token Network Utility](#)

[Staking Mechanisms](#)

[Ecosystem Governance](#)

[References](#)

[Glossary](#)

[Appendix: Example Ecosystem Applications](#)

[Appendix: Disclaimer](#)

Guru Enlightenment Network(GEN) Introduction

DexGuru is evolving its internal Developer Tooling into the Guru Enlightenment Network(GEN), driven by our need for Multi-Chain Orchestration for Guru solutions deployed across 18 blockchain networks. These products, which include the Guru Block Explorer and Data Warehouse, have been publicly operational since July 2023 and DeFi Trading Terminal since February 2021. Execution core of the Guru Developer Toolset is Flow Orchestrator, initially an internal tool for cross-product Blockchain Business Process Automation (BBPA), employing the [BPMN](#)(Business Process Management and Notation) standard [1] standard for defining process manifests.

Process definitions are deployed onto the Flow Orchestrator and can be instantiated from there. Alongside the BPMN[1] definition deployed on the Web2 Flow Orchestrator, a corresponding Factory Smart Contract (SC) representing the same process definition is deployed on-chain. This design facilitates the creation of Blockchain Business Process Management (BBPM) definitions.

From the very beginning we decided not to "reinvent the wheel" and extended traditional BPA engines to support BBPM. We have been evaluating popular open-source projects like [Camunda Platform 7](#)[2] and [Flowable](#)[3] for this purpose since November 2023. We chose to build on top of Camunda, also its [Apache License 2.0](#) license allowed a public open source path for us. The Flow Orchestrator, in the form of the Camunda Web3 extension, was first released and utilized in production in December 2023. It has since been extensively used by the Guru team to orchestrate user flows and AI/business processes across our suite of B2B and retail products.

Our internal assessments show that this Developers Tooling Architecture significantly aids the Guru Team in rapid development and operational control. The [Flow Orchestrator Framework](#)[5] on GitHub includes BBPA Engine, Smart Contracts, Individual Agents, and GUI allowing us to quickly spin up new applications and integrations. This framework was also tested for external party integration when it was utilized by one of the teams at the ETHDenver 2024 Hackathon.

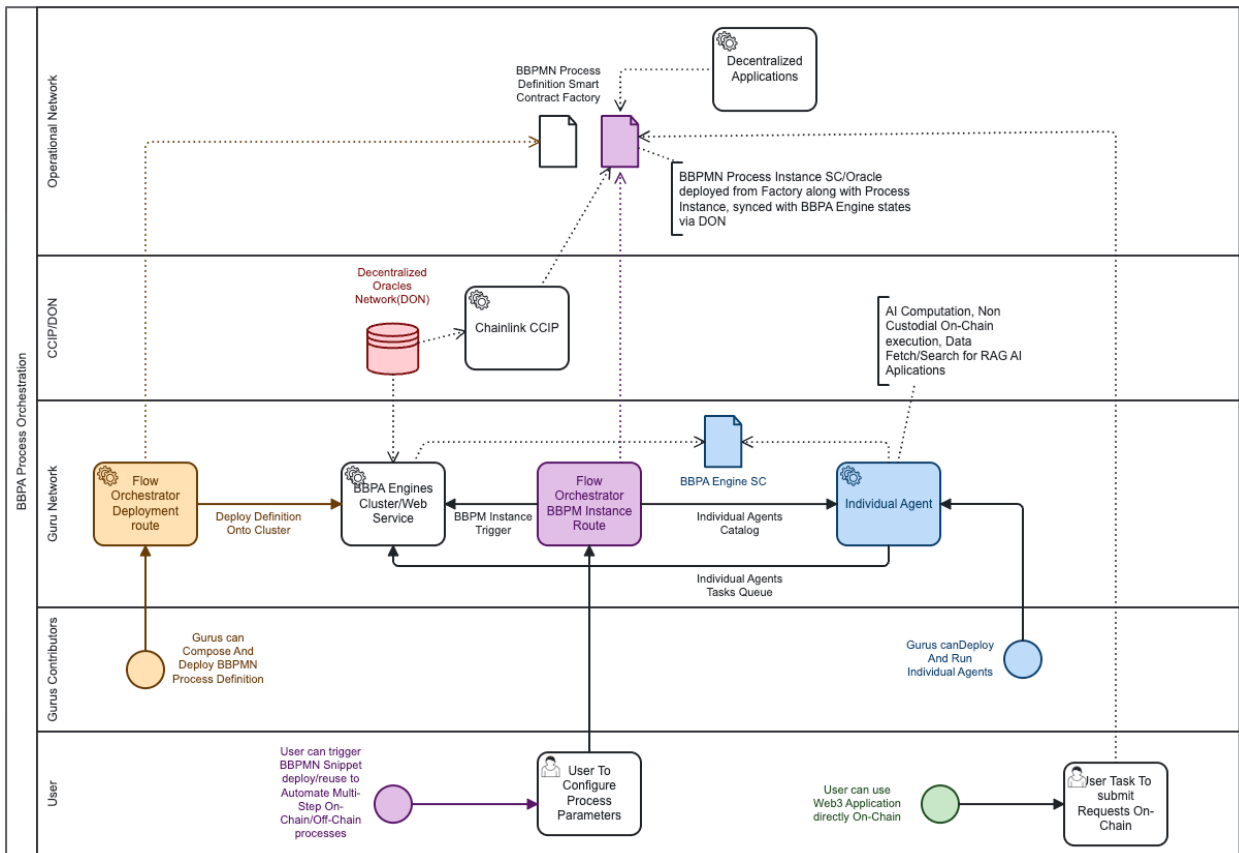

We plan to scale and decentralize this approach by productizing the Flow Orchestrator and Data Warehouse into what will be known as the Guru Enlightenment Network(GEN). Here are the main design decisions we've made:

1. We envision a clustered environment of BBPA Engines with on-chain counterparts deployed as Engine SC and BBPM Process Definition Factory SC[5]. These Smart Contracts, deployed onto the Guru Network, synchronize the state across engines.
2. Expanding on these architectural considerations, we aim to utilize the Cross-Chain Interoperability Protocol (CCIP)[6] for orchestrating multi-chain activities, moving away from the centralized Flow Orchestrator model currently used internally by the Guru team. The operational architecture comprising the Flow Orchestrator, BBPA Engines, and the Guru Network functions as Oracles for DON (Decentralized Oracle Networks)[7].
3. CCIP allows for multi-chain messaging and value transfers(ERC-20), which can be utilized by Flow Orchestrator as a value transfer mechanism defined on task level in BBPM definitions.
4. This setup allows for multi-chain Operational Chain <-> CCIP[6] <-> DON(Guru exec) <-> BBPA Engines <-> Guru Network orchestration, with well known Oracle interfaces designed to act as a compute layer for dApps, either deployed on their operational chain or across multiple chains.

Those core design principles identify the foundation of Guru Enlightenment Network, Guru Community and Ecosystem growth.

Network Participants Ecosystem

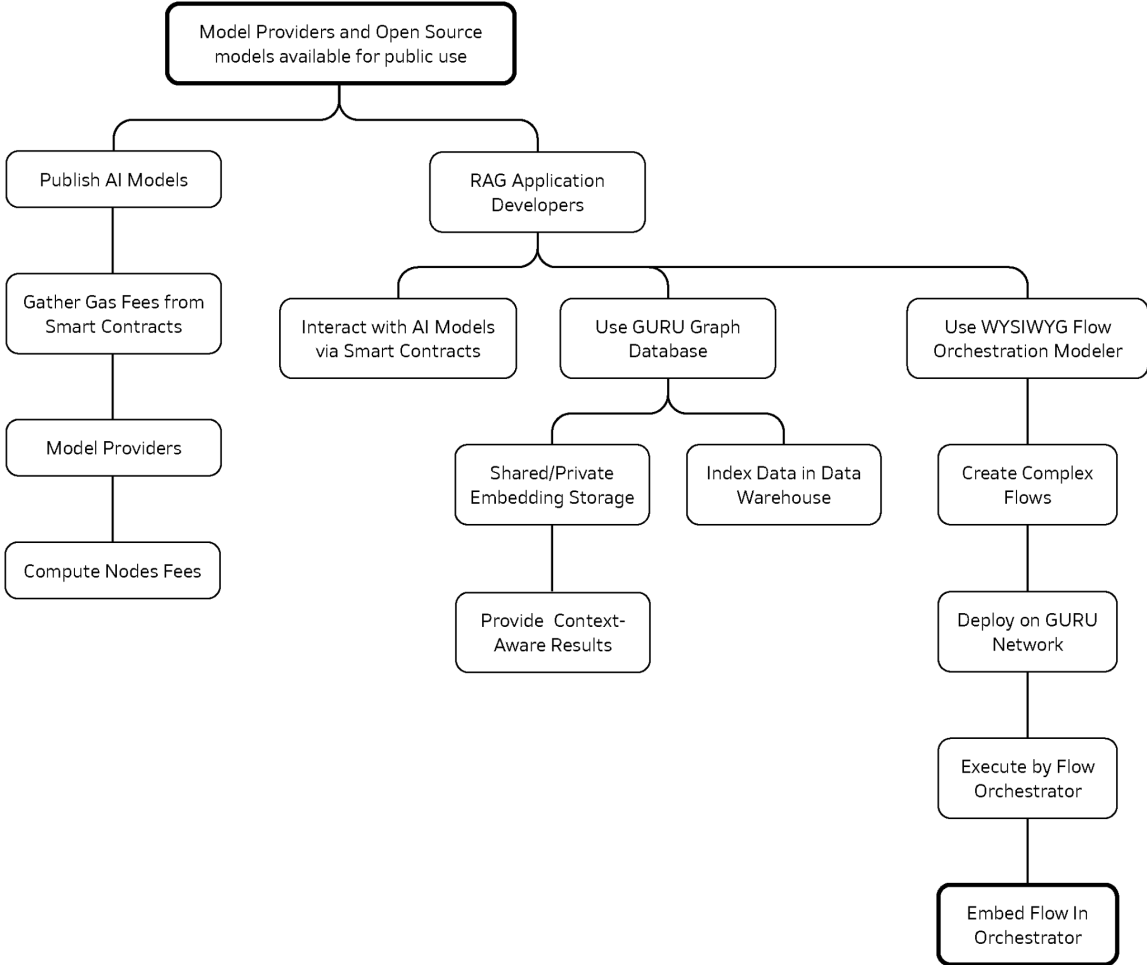

As the Guru Network expands, it leverages a diverse ecosystem of contributors and users, each playing a crucial role in the network’s operation and growth. These various participant categories within the Guru Network, including Gurus, Ecosystem Projects, Individual Agents, Integrators, and Retail Users. Each category contributes uniquely to the network's ecosystem, from developing AI-driven solutions to enhancing blockchain interoperability and user engagement. Understanding these roles is essential for appreciating the network’s comprehensive architecture and collaborative dynamics.

- **Gurus:** This category encompasses AI Processors, Compute Node Runners, and Individual Agents code contributors.

- **Ecosystem Projects:** Retail and business projects serve as entities that combine multiple BBPA (Blockchain Business Process Automation) orchestrations and data scenarios to solve specific routine tasks or business functions. These projects can also act as Gurus by contributing AI Processors and GURU AI Assistants to the network. They have the opportunity to publish their AI Processors, GURU AI Assistants, and Individual Workers in a IAAS(infrastructure-as-a-service) catalog, making them available for integration by other participants in the ecosystem.
- **Individual Agents:** AI/Non-Custodial Web3 Processors composed by Gurus and run by Compute nodes, utilized by BBPM defined processes.
- **Integrators:** For enterprise implementations, integrators serve as a middle layer providing B2B adoption of the Guru AI Flow Orchestrator and Framework.
- **Retail Users:** Retail users utilize the network as assistants from their wallets. Additionally, the architecture allows for them to participate in "Compute by Earn" when idle functionality, where they choose which Individual Agents to run when their device/wallet is idle.

The Guru Enlightenment Network thrives on the collaboration between Gurus, who innovate with AI technologies, ecosystem projects and active retail users, enhancing both functionality and scalability.

Web3 Infrastructure

The Guru Network is architecturally designed as a Layer 3 solution on the base stack for multi-chain AI orchestration, leveraging Chainlink's Cross-Chain Interoperability Protocol (CCIP). Guru Network is gearing up for the launch of an incentivized Testnet at Phase1, using this Base Layer 3 technology. This layer enables dApps and retail users to seamlessly integrate orchestrated AI Agents into their daily routines and earn rewards as active network participants.

Flow Orchestrator

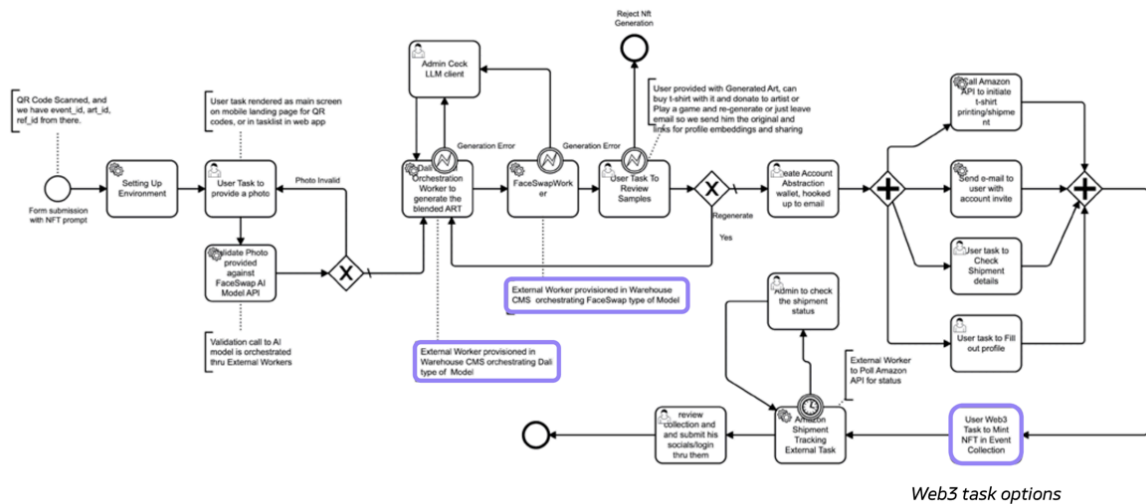

The Flow Orchestrator, a central component of our Web3 infrastructure, harnesses AI processors equipped with comprehensive data sourced from the Guru Data Warehouse, Analytics driven Block Explorer and DeFi trading terminal deployed on Guru Network. This setup reduces the manual complexities typically associated with Web3 technologies, which can hinder adoption and lead to user errors. By automating and battle-testing processes, the Flow Orchestrator ensures efficient blockchain orchestration within the Guru Enlightenment Network, enhancing operational efficiency and maximizing network value.

BBPA Engine Event Bus as Network Native Oracle

As we continue to enhance the usability and interoperability of orchestrated BBPM processes, we plan to integrate the Flow Orchestrator Event Bus as an interface that can be queried through oracles within the Guru Network. Currently, the Flow Orchestrator event bus feeds into Elasticsearch storage, which is accessible via the Guru Data Warehouse. Moving forward, we aim to expose this data on-chain, leveraging the centralized Elasticsearch storage in a selective manner based on the specific needs within ecosystem process definitions. This approach will streamline data accessibility and enhance real-time data integration across the network, fostering greater transparency and efficiency in process orchestration.

AI Compute Oracles as Prophets

In the context of the Guru Network, a Prophet refers to an advanced predictive mechanism that extends the traditional oracle concept (typically used for sensor data) to include prediction generation capabilities. Prophets are utilized within the AI Compute Orchestration as Verifiable Truth Sources and Base Truth Oracles. As BBPA (Blockchain Business Process Automation) Engines achieve sufficient decentralization, they can serve as Base Truth Oracles for specific AI Processors. This role is crucial in filtering out hallucinative responses from Language Learning Models (LLMs)

and maintaining the relevance of automated responses. By ensuring that AI-driven processes are based on verified and reliable data, Prophets enhance the accuracy and applicability of automated decisions across the network

Real-World Impact and Network Growth

Through the Guru Enlightenment Network, AI Gurus tackle real-world business challenges across multiple chains by integrating them into the Decentralized Oracle Network. This approach not only brings efficiency but also drives practical innovations that meet the evolving demands of the digital landscape. The synergy between Gurus—who innovate with AI technologies— Ecosystem projects — and active retail users, who enhance network functionality and scalability, enhances the ecosystem growth in integrating user flows with AI and blockchain technology.

User Engagement and Participation

Retail users engage with the network by utilizing AI assistants directly from their wallets. Furthermore, the BBPA Engine in wallet architecture supports a "Compute to Earn" functionality allowing users to select which Individual Agents to run, when devices or wallets are idle. This feature encourages active participation and contributes to the network's collaborative ecosystem.

Web2 and Off Chain Infrastructure

BBPA Engine REST API

We utilize Camunda Platform 7 as the open-source foundation of Flow Orchestrator Nodes it offers an extensive [REST API](#)^[9] out of the box. REST API designed to enable BPA(Business Process Automation) integrators to build various front-end applications atop the orchestration system. All the states of the processes instantiated from BBPM process definition items are accessible through these REST APIs hosted on BBPA Engine, allowing for object interactions and state queries. These APIs can be exposed to Web2 applications either directly through the BBPA Engine node or via a Flow Orchestrator proxy that handles all requests from multiple tenants

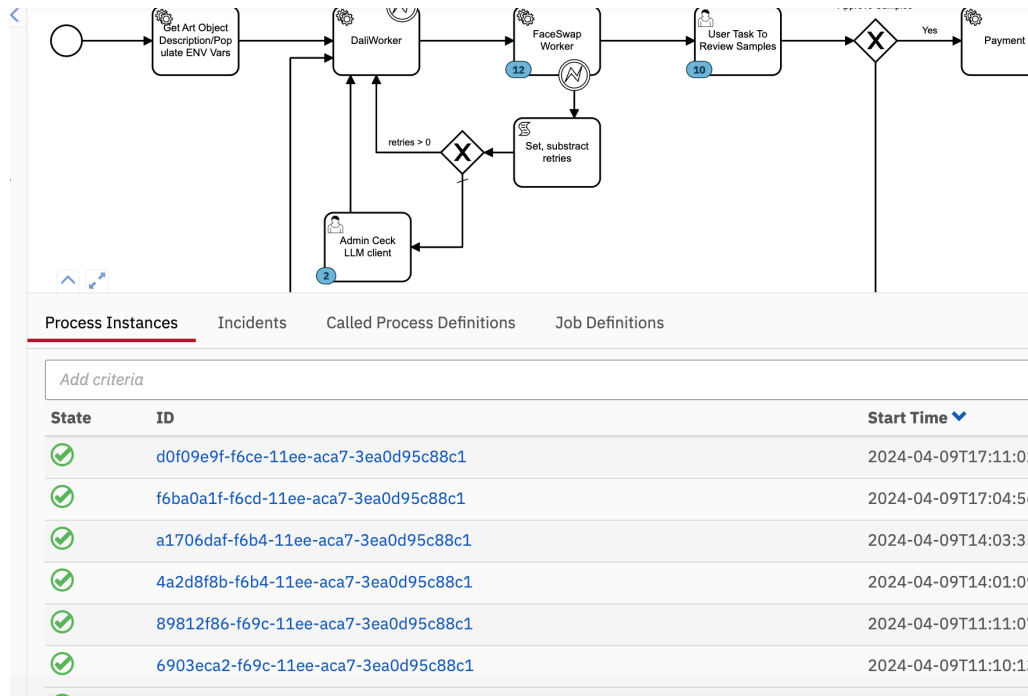

The GUI package included in the Guru Framework is already equipped with mechanisms to service user tasks orchestrated by the Engine. It features modal windows of various types and is integrated with process instance deployment capabilities, enabling the initiation of predefined BBPA processes. Additionally, the event bus of the engine is accessible through Historical APIs, which store a comprehensive history of all activities and variable states.

BBPA Engine Tasklist

The BBPA Engine orchestrates two main types of tasks externally: Individual Agents (IA) Tasks and Gurus Tasks, those are divided based on functionality:

- **Generic Individual Agents (IA) Tasks:** These are queues for IA Lambda functions that handle AI Compute, comprehensive interaction scripts, or non-custodial transaction execution on the blockchain. These tasks facilitate the processing and execution of complex data and transactions, integrating seamlessly with various AI-driven processes.
- **Gurus Tasks:** Presented within the user's task list, these tasks function as user interaction and feedback UI elements across integrated frontends and chatbots. This setup enhances off-chain orchestration of routines and business processes through an easy-to-use interface that has been extensively tested across thousands of integrations in traditional finance (TradFi) businesses utilizing BPMN-based BPA systems.
- **Gurus Web3 Tasks:** This task type provides a user transaction builder interface, which orchestrates the transaction process and prompts users to complete tasks through their wallet. This functionality allows for the encapsulation of various DeFi routines into a single decision point, which can be automated through an IA Non-Custodial Worker implementation.

- Non-Custodial Individual Agents (IA) Tasks: These tasks are designed for automated signing and execution by a container running on the user’s controlled hardware. They enable different scenarios for automating crypto activities, enhanced by AI processors, allowing for sophisticated, secure crypto operations. Example here could be wrapped [Guru DeFi Meta Aggregation API](#)[11] wrapped as Individual agent operating in non custodial fashion.

Access to these tasks, whether in their current state or a form optimized for integration, is provided through both Web2 (REST API) and Web3 (BBPM Process Instance SC Variables) interfaces. The choice of interface depends on the deployers' need for decentralization mechanisms, offering flexibility in how tasks are managed and executed within the Flow Orchestrator.

AI Compute Individual Agents Ecosystem

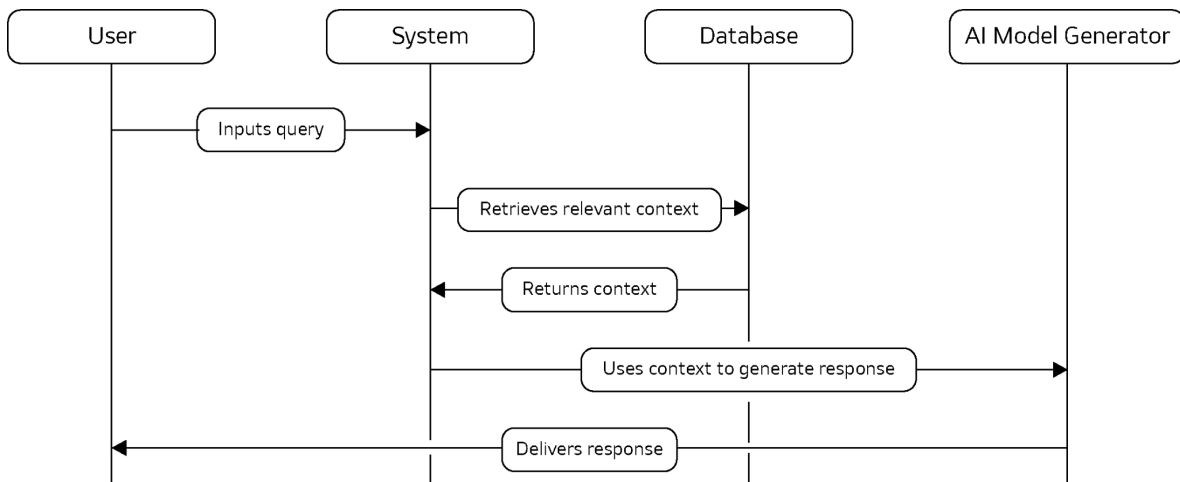

AI Compute IA ecosystem represents the decentralized autonomous computational entities. Integrated across the ecosystem within the composed BBPM Process definitions to serve as Network AI compute layer and data analytics toolset. These agents, facilitated by the Guru Flow Orchestrator and governed by Blockchain Business Process Management (BBPM) definitions.

Ecosystem allows users from various sectors to leverage sophisticated AI tools within a secure and user-friendly environment.

Data aware Individual Agents Ecosystem

Guru Data Warehouse, enabling Individual Agents and AI processes to tap into a rich vein of structured and unstructured data. Such access not only enhances the precision and relevance of AI activities but also fosters the development of custom solutions provided by ecosystem Integrators.

By integrating proprietary business logic, the Guru Network empowers ecosystem participants to embed their unique operational methodologies directly into AI models, enhancing the models'

ability to deliver targeted outcomes and actionable insights. This capability ensures that businesses can maintain a competitive edge by developing AI-driven strategies that resonate with operational goals.

Data aware IA Ecosystem is poised to find new use cases in business automation and AI driven decision-making processes.

Ecosystem Atomic Franchise Mechanism

The ecosystem operates under the principles of the Atomic Franchise Mechanism (AFM), which are facilitated by BBPM (Blockchain Business Process Management) definitions. These definitions are deployed onto BBPA (Business Process Automation) Engines within the GURU Network. Individual Agents function as Lambda functions for serverless computing of AI Processors. Ecosystem projects integrate these BBPM Process Definitions into their workflows using the GURU Flow Orchestrator for deployment and management, along with the Framework SDK as the core for projects and integrations.

Ecosystem participants have the opportunity to publish their AI Processors and AI Assistants in the IAAS Catalog. Instances of BBPM processes, derived from these definitions, orchestrate users, Individual Agents (for AI computing and non-custodial execution), and on-chain actions across multiple chains where ecosystem dApps operate. This enables the creation of new economic models within the Guru Enlightenment Network, where participants share their business processes, routine optimizations, and proprietary intellectual property (in the form of Individual Agents) across the ecosystem as Infrastructure-as-a-Service (IaaS). Conversely, Gurus, users, and ecosystem projects can integrate these infrastructure flows into their BBPMs for use in business processes and Web3/Web2 applications.

When deploying a flow based on snippets from other participants, there are two types of fees involved, which contributors (Gurus) can specify during the publishing or BBPMN: an instantiation fee and rates for Individual Agents (as decentralized serverless AI Compute).

Consider a scenario where a company predominantly sells goods through platforms like Amazon, eBay, and to insurance companies. These sales funnel into a unified support pipeline where the context of an order, along with account and product details, are merged in an AI Processor BBPM Definition. Multiple Individual Agents running AI models are orchestrated to manage this data. As a result of these integrations, the company can offer both BBPMs and Individual Agents in the Guru IAAS catalog, utilizing individual workers and resources to address specific support chat challenges effectively.

Ecosystem Rewards and Incentives

Gurus and Individual Agents are primarily incentivized through two revenue streams:

- Instantiation fees from BBPM processes listed in the Guru IAAS Catalog.
- Fees from providing their Individual Agents (IA) as IAAS(infrastructure-as-a-service).
These agents support network operations by offering their infrastructure for computational tasks.

Rewards are earned for initiating processes and offering infrastructure, thus contributing to the AI Compute layer of Guru Enlightenment Network(GEN). Furthermore, this infrastructure, managed by the Flow Orchestrator's Task Queue Interface, can be developed into proprietary intellectual property (IP), which allows for the commercialization of customized business and AI models or non-custodial cross-chain computations.

Multi Chain Interoperability Layer (CCIP)

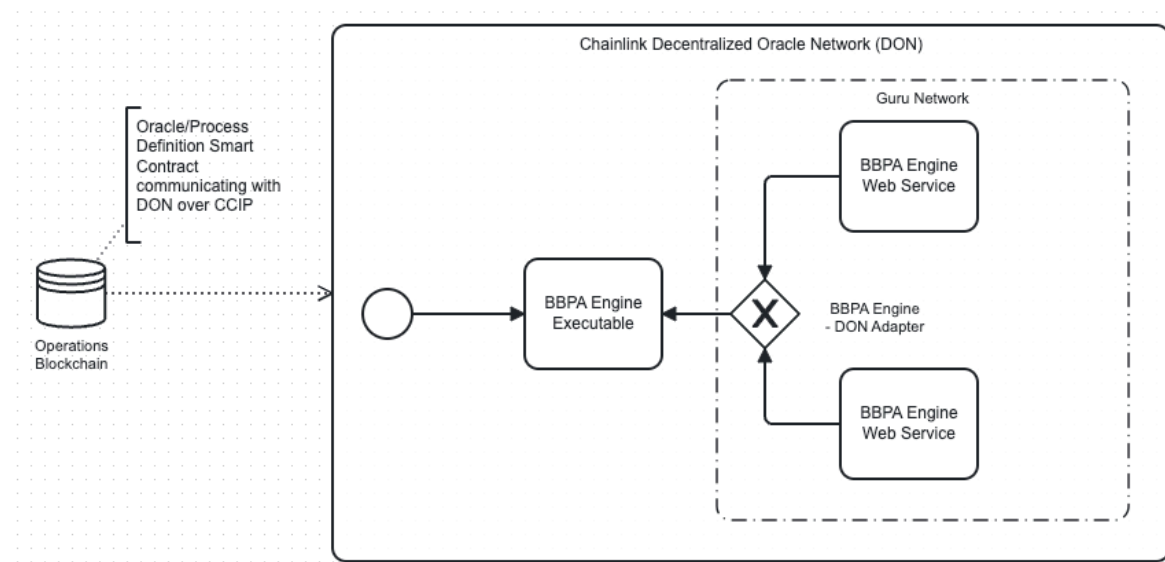

The Guru Network is set to advance its architecture by integrating Chainlink's Decentralized Oracle Network (DON), ensuring secure and efficient processing of off-chain computations and data feeds. This integration will enhance robust interoperability through the Cross-Chain Interoperability Protocol (CCIP), extending beyond our current centralized Flow Orchestrator model. The CCIP is already functional on multiple blockchains including Arbitrum, Avalanche, Base, BNB Chain, Ethereum, Kroma, Optimism, Polygon, and WEMIX, and is poised for further expansion, enhancing both the Guru Network and the Flow Orchestrator's multi-chain capabilities.

This upgraded architecture not only supports multi-chain messaging and ERC-20 token transfers but also improves scalability and performance across various sectors like finance, supply chain, and automated customer interactions. These sectors stand to benefit from AI-driven dynamic

optimizations and data-driven decisions, utilizing CCIP's capabilities for value transfer mechanisms defined at the task level in BBPM (Blockchain Business Process Management) definitions.

Guru Network <-> DON integration focused on AI Compute Orchestration expands the Oracles concept(sensor data) towards Prophets(prediction generator for future data) implementation.

The operational trio of the Flow Orchestrator, BBPA Engines, and the Guru Network acts as the oracle infrastructure within DON, streamlining processes and maintaining integrity and confidentiality across diverse platforms. For a detailed exploration of these integrations and our future strategies, please refer to the "Building [The AI Orchestration Network: Blockchain Business Process Automation Architecture](#)" whitepaper [8], which covers the "Guru Network <-> Chainlink DON <-> CCIP" integration extensively.

Roadmap

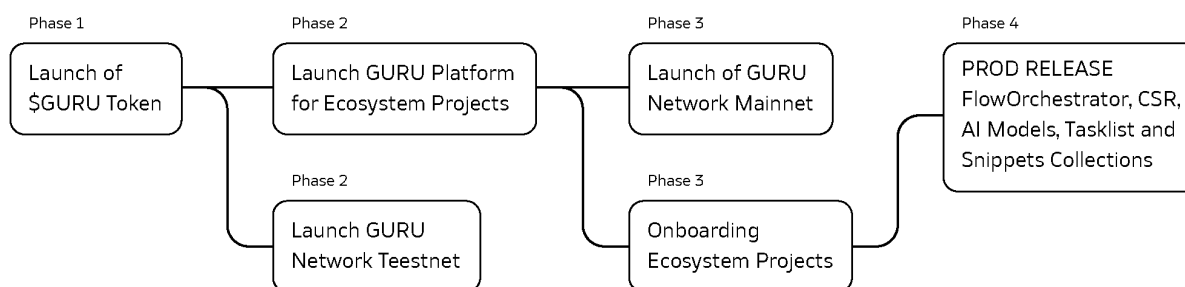

Our commitment to the GURU Network goes beyond its architectural and economical design; it is also the foundation for the next evolution of our existing products. By running services using GURU Network as infrastructure, we demonstrate capabilities and refine functionality to ensure the platform meets the high standards users expect. This approach allows us to closely align our products' development with the emerging needs of the blockchain community, ensuring that our solutions remain at the cutting edge.

\$GURU Token Network Utility

The \$GURU token underpins the economic operations of the Guru Network, serving as a fundamental element of the [Contract Secured Revenue](#) (CSR)[10] model. This model strategically distributes transaction and service fee revenues among various network participants, thereby nurturing a robust ecosystem. CSR incentivizes Gurus, ecosystem projects, individual agents, integrators, and retail users, boosting their engagement and contributions to the network. From a Web3 perspective, the economic utility of the \$GURU token bridges diverse network roles and the

Multi-Chain AI compute layer through the Chainlink Cross-Chain Interoperability Protocol (CCIP), facilitating the transfer of messages and value. Off Chain, the demand for Blockchain Business Process Automation (BBPA) orchestration is met through an Infrastructure-as-a-Service (IaaS) powered by the \$GURU token, readily accessible via Web2 tooling.

Staking Mechanisms

Staking within the GURU Network involves locking \$GURU tokens to support network operations and security. Participants are rewarded for their contributions, which include securing the network and facilitating transactions. Staking is a foundational element of the network's economic model, incentivizing participation and long-term commitment from its users..

Ecosystem Governance

Ecosystem projects and Gurus are planned to have governance stake in the GURU Network Ecosystem. The exact framework of the future governance system will be provided at a later date, before the mainnet launch. The main mechanics and governed “handles” would be tested during the Testnet phase.

References

1. BPMN(Business Process Management And Notation) standard. Available at: <https://www.bpmn.org/>
2. Camunda | The Universal Process Orchestrator. Available at: <https://camunda.com/>
3. Flowable Platform | Low-code Automation. Available at: <https://www.flowable.com/>
4. Camunda Apache 2.0 License. Available at: <https://github.com/camunda/camunda-bpm-platform/blob/master/LICENSE>
5. Flow Orchestrator Framework. Available at: <https://github.com/dex-guru/guru-framework/tree/main>
6. Cross-Chain Interoperability Protocol (CCIP). Available at: <https://docs.chain.link/ccip>
7. Breidenbach, L., Cachin, C., Chan, B., Coventry, A., Ellis, S., Juels, A., Koushanfar, F., Miller, A., Magauran, B., Moroz, D., Nazarov, S., Topliceanu, A., Tram`er, F., Zhang, F. "Chainlink 2.0: Next Steps in the Evolution of Decentralized Oracle Networks." 15 April 2021. Available at: Chainlink 2.0 Whitepaper v1.0.
8. Vakhteev, E., Volynshchikov, A. "Building The AI Orchestration Network: Blockchain Business Process Automation Architecture" 1 May 2024. Available at: https://gurunetwork.ai/assets/img/guru_network_architecture_whitepaper.pdf
9. Camunda Platform 7 REST API Specification. Available at: <https://docs.camunda.org/rest/camunda-bpm-platform/7.20/>
10. Introducing CIP-1 Contract Secured Revenue (CSR): Tokenized Fee Sharing for Canto Builders. Available at: <https://canto.mirror.xyz/QjMcVxG65ScvuKouMQ9W7Iogyo77jrEUIKibxWz0ebI>
11. GURU Meta Aggregation API Github Repository. Available at: <https://github.com/dex-guru/meta-aggregation-api>

Glossary

Guru Enlightenment Network (GEN) - A decentralized network within the Guru ecosystem that leverages AI and blockchain technology to facilitate seamless orchestration of business processes. GEN integrates advanced AI processors and blockchain oracles to enhance operational efficiency and ensure reliable, data-driven decision-making across multiple industries.

Flow Orchestrator - A tool within the Guru Network that manages and orchestrates the deployment and operation of BBPA engines and AI processes.

GURU AI Assistants - Advanced AI tools within the Guru Network that assist in managing and optimizing blockchain-based business processes.

GURU Data Warehouse - A centralized repository that stores comprehensive data used by AI Compute Individual Agents for enhanced decision-making and process automation.

IAAS (Infrastructure-as-a-Service) - A model within the Guru Network where AI Processors, AI Assistants, and Individual Workers are made available for integration by other ecosystem participants.

Integrators - Entities or individuals that provide B2B adoption of the Guru AI Flow Orchestrator and Framework, facilitating enterprise implementations.

Retail Users - End-users of the Guru Network who utilize AI assistants from their wallets and participate in network activities to earn rewards.

AI Compute Individual Agents (IA) - Autonomous computational entities within the Guru Network that perform specific AI-driven tasks to support automated business processes.

BBPA (Blockchain Business Process Automation) Engine - The automation engine running business processes On-Chain and Off-Chain integrating AI and blockchain to enhance efficiency and accuracy.

BBPM (Blockchain Business Process Management) - The management of blockchain-based business processes that involve multiple orchestration and data scenarios to solve specific business functions.

BBPM Process Definition Factory SC - Smart Contracts that represent the BBPM process definitions and synchronize state across the network's engines.

CCIP (Cross-Chain Interoperability Protocol) - A protocol that enables secure and efficient messaging and value transfers across different blockchain networks.

CSR (Contract Secured Revenue) - A revenue model in the Guru Network where transaction and service fees are distributed among network participants, fostering ecosystem sustainability.

DON (Decentralized Oracle Networks) - Networks that provide reliable data to blockchain networks to facilitate operations and enhance security.

Prophet - A predictive tool in the Guru Network that enhances traditional oracles by generating predictions for sensor data, serving as Verifiable Truth Sources and Base Truth Oracles. Prophets ensure that AI-driven decisions are based on accurate and reliable data, crucial for eliminating hallucinative responses from Language Learning Models (LLMs).

Appendix: Example Ecosystem Applications

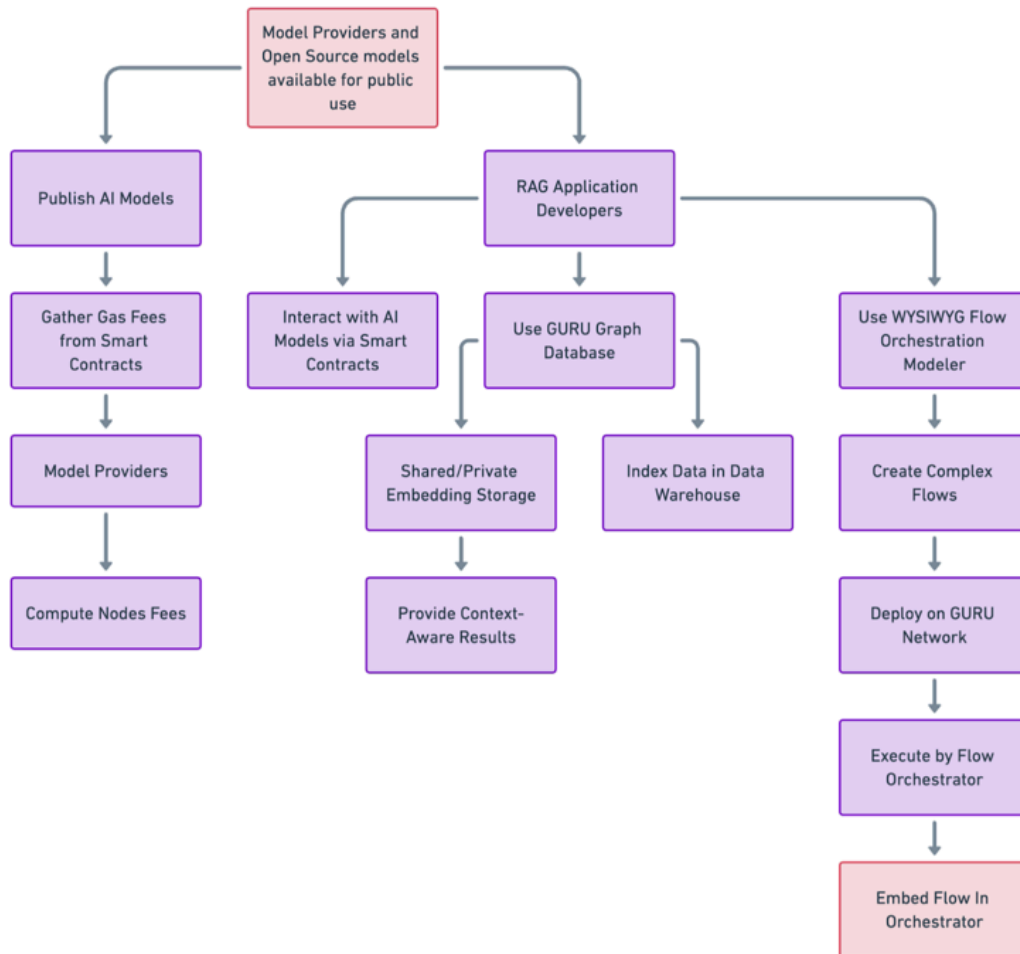

1. dApp Developers:

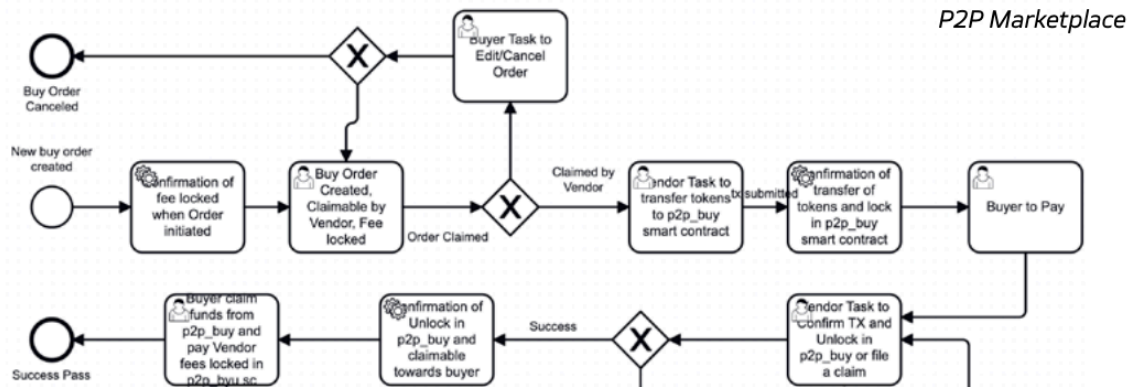

- Utilize blockchain data dashboards and pages as no-code solutions integrated directly into front-ends.
 - Employ ready-to-use, battle-tested process snippets for rapid, low-code development.
 - Handle asynchronous user interactions or support scenarios via a task list interface.
2. **RAG Applications Developers and AI Models Providers:**
- Leverage a variety of supported models and providers within the ecosystem.
 - Use templates for easy integration of GPT-type requests, distributed across compute nodes.
 - Create, store, and query embeddings for RAG context to enhance application functionality.
3. **Network Participants:**
- Operate as validator nodes, providing consensus, governance, AI model, and data verification services.
 - Earn computation fees through Contract Secured Revenue by running AI models.
 - Utilize the Guru Wallet SDK to run compute tasks, enhancing participation and earnings.
4. **Enterprise Applications:**
- Integrate RAG mechanics for blockchain transactions, assets, and data dashboards directly into enterprise systems.
 - Enhance business processes with AI-driven insights and automation, promoting efficiency and innovation.
5. **SocialFi Applications:**
- Orchestrate social mechanics and gamify application experiences to facilitate seamless blockchain onboarding.
 - Use orchestrated multi-step AI models to create engaging and interactive user experiences.
6. **Chatbots and Personal Assistants:**

Non Custodial Sniping Bot

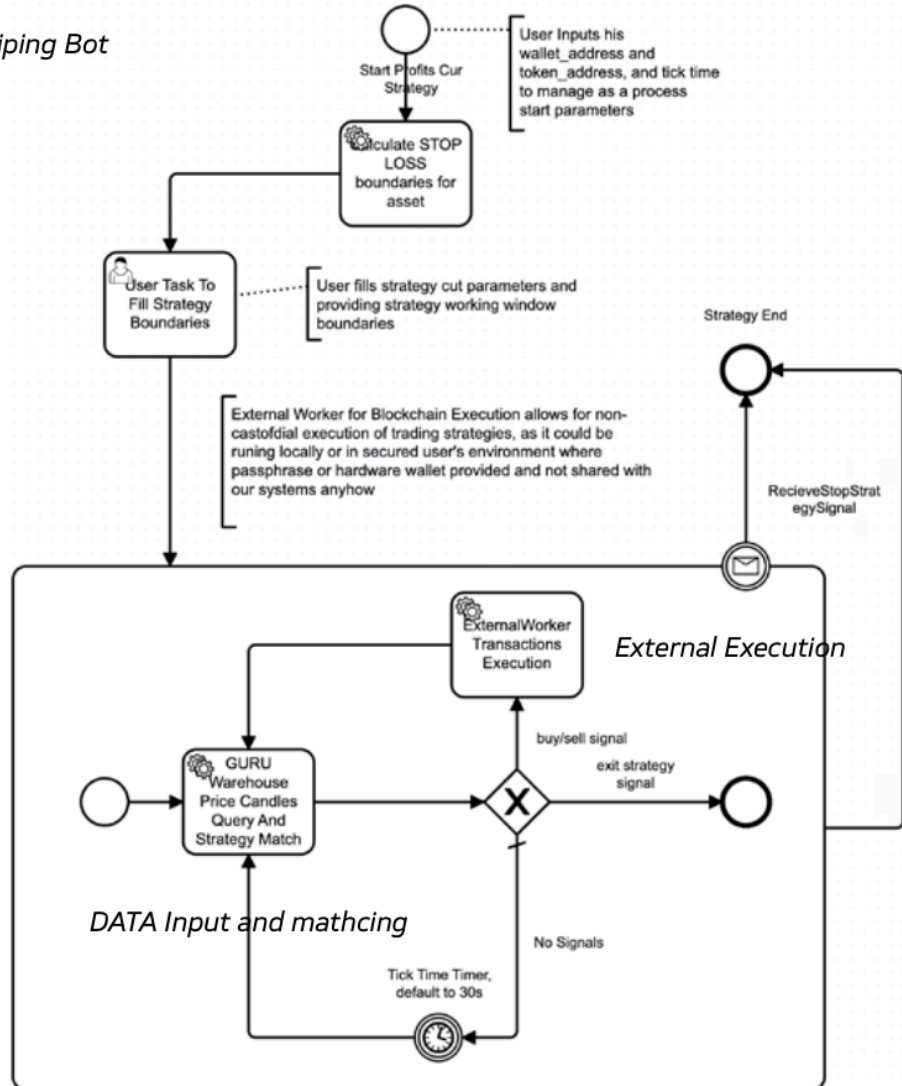

- Develop chatbots for platforms like Telegram and Discord using the SDK, enabling easy orchestration of tasks and AI interactions.
- Implement non-custodial execution features for secure, decentralized operation of chatbots and personal assistants.

7. GAMEDev Tooling:

- Provide game developers with tools to focus on game design and mechanics rather than financial and AI orchestration aspects.
- Utilize AI for game item generation and management, integrating blockchain functionalities seamlessly.

Appendix: Disclaimer

This paper is for general information purposes only. It does not constitute investment advice or a recommendation or solicitation to buy or sell any investment and should not be used in the evaluation of the merits of making any investment decision. It should not be relied upon for accounting, legal or tax advice or investment recommendations. This paper reflects current opinions of the authors and is not made on behalf of DexGuru, or their affiliates and does not necessarily reflect the opinions of DexGuru, their affiliates or individuals associated with them. The opinions reflected herein are subject to change without being updated.